

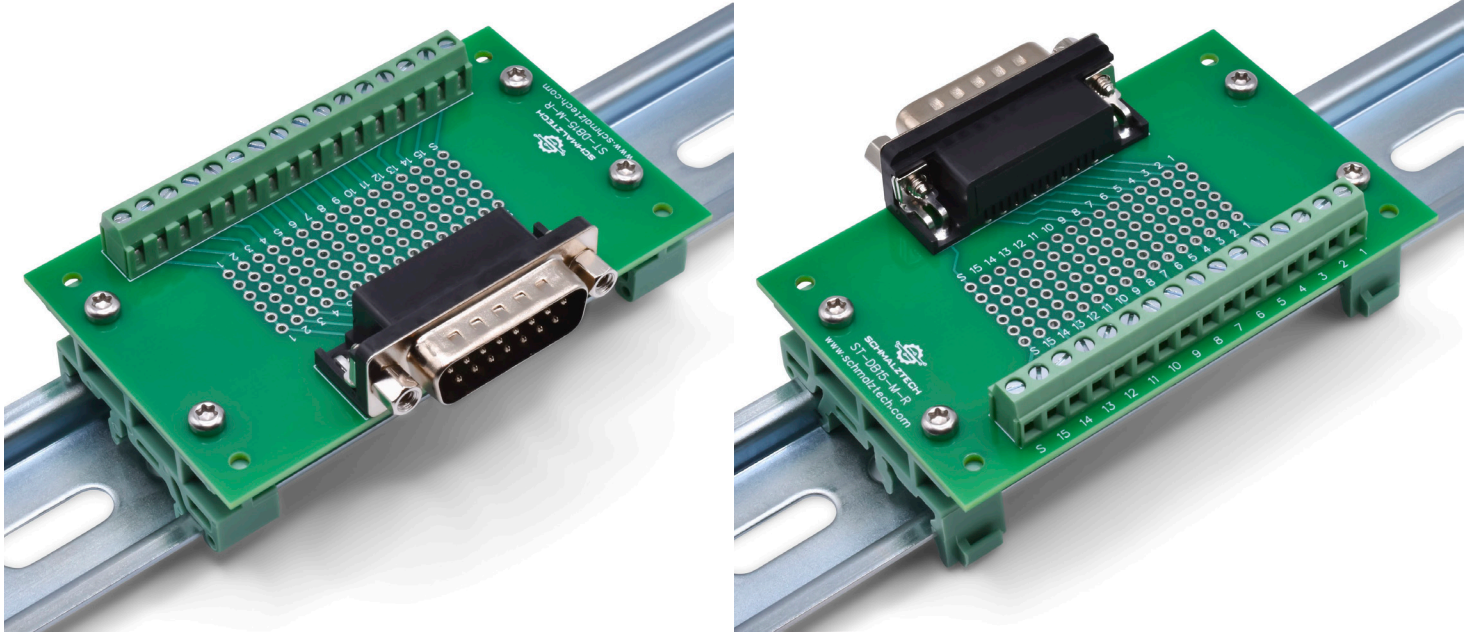

ST-DB15-M-R-DIN

Male DB15 Breakout Board with DIN Rail Clips



- Breaks out all 15 contacts + shield
- Screw terminals for fast connections
- Prototyping area for in-circuit modifications
- Easy access for probing and debugging
- Easily mounts on 35mm DIN rail

Specifications	
Wire Range (stranded)	16-26 AWG
Wire Range (solid)	16-26 AWG
Connector	DB15 - Male
PCB Surface Finish	LF HASL
Temperature Rating	-15°C to +70°C

This male DB15 breakout board provides a convenient method of accessing all the contacts of a 15-pin D-Sub connector. Each of the 15 connections as well as the shield are brought out to a screw terminal for fast and secure termination to wires. This board also features a prototyping area to enable in-circuit modifications as well as easy probing/diagnostics. The prototyping grid has a standard 0.1" pattern to enable compatibility with a variety of components. The DIN clips on this model allow it to be easily used with a 35mm DIN rail system, making this board perfect for industrial applications.



ST-DB15-M-R-DIN

Male DB15 Breakout Board with DIN Rail Clips

Mechanical Drawings

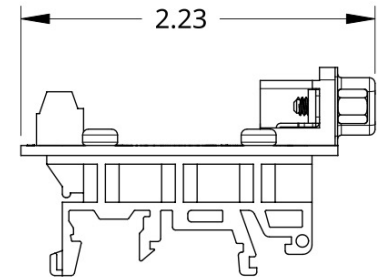
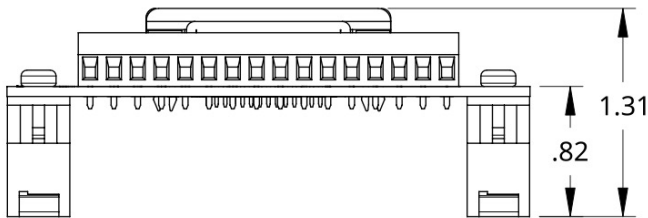
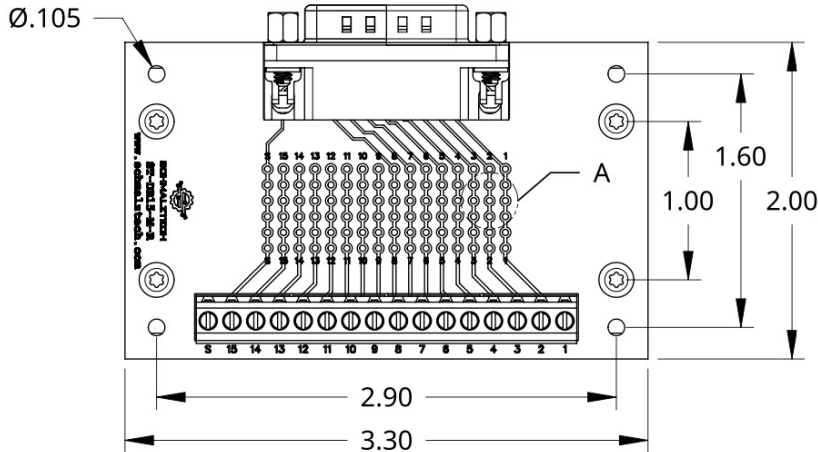

Electrical Connections

Each pin of the DB15 connector is electrically connected to a single row of the prototyping area and to one screw terminal. The pads of the prototyping area have a standard 0.1" pitch.



ST-DB15 - Ordering Information

ST-DB15- _____ - _____ - _____

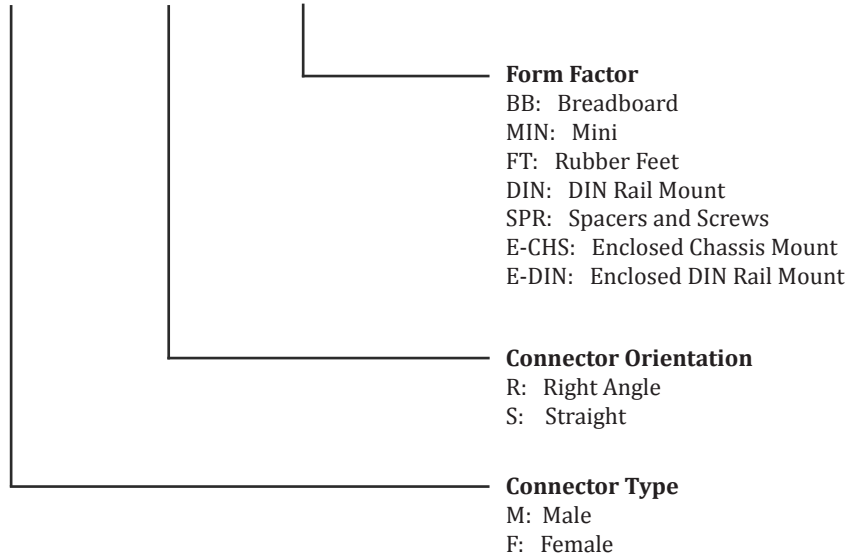

Ordering

To order please visit www.schmalztech.com or one of our distributors to quickly place an online order.

Orders may also be placed by email or phone:

Email: sales@schmalztech.com

Phone: +1 (844) 399-9213

Expedited Shipping

If overnight shipping is required please contact us directly so that we can expedite your order. Overnight shipping is provided through UPS and will incur an additional charge

Custom Designs

Can't find what you need? We can design and produce a custom board to fit your exact needs. Please reach out to us for additional information and pricing.